

Section 13

MISCELLANEOUS HARDWARE

13 - MISCELLANEOUS HARDWARE



VEHICLE WATER TANKS

Black in Colour Australian Roto-Moulded Plastic product. Typically fitted under the tray of utes, service vehicles or trucks, unit features a soap or sunscreen dispenser. Interchangeable for left or right installs.

Part No. MH0002

15Ltr:

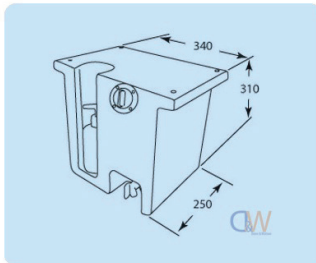

Part No. MH0003

23Ltr:

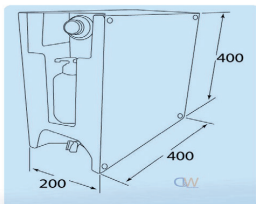

Part No. MH0004

30Ltr:

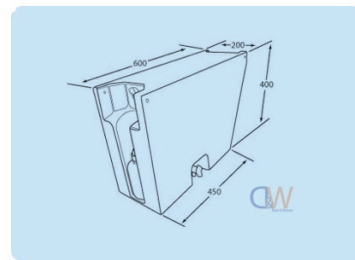
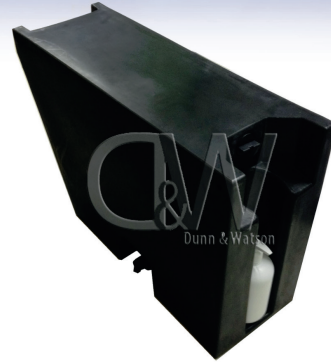

Part No. MH0005

60Ltr:

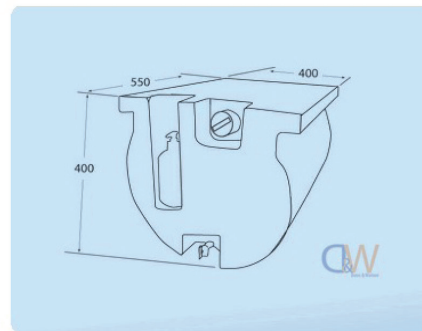

Part No. MH0006

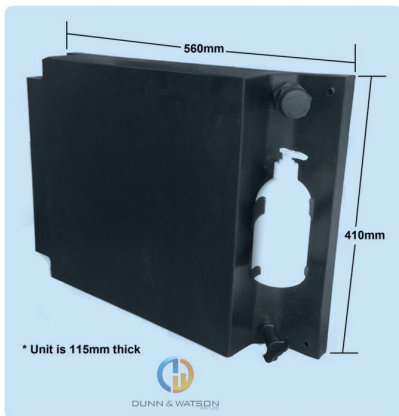
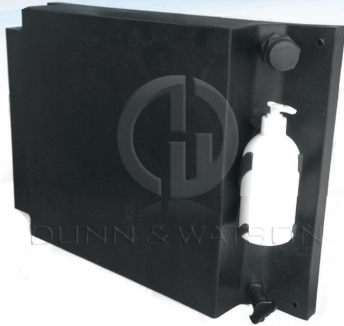

Part No. MH0007

4x4 Water Tank
 Dimensions:
 500mm Long x 220mm Wide x 240mm Deep

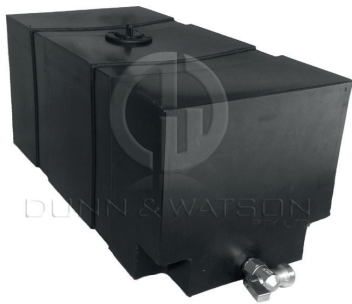

Part No. MH0008

65 Litre Water Tank
 Dimensions: 810L x 610W x 200D



Part No. MH0009

80 Litre Water Tank
 Dimensions: 810L x 610W x 250D



Part No. MH0010

140 Litre Water Tank
 Dimensions: 1200L x 700W x 180D



CAMPER TRAILER AND CARAVAN ACCESSORIES:

Camper Trailer Kitchen - Tailgate Mounting:

Part No. MH0021

Right Hand Swing:

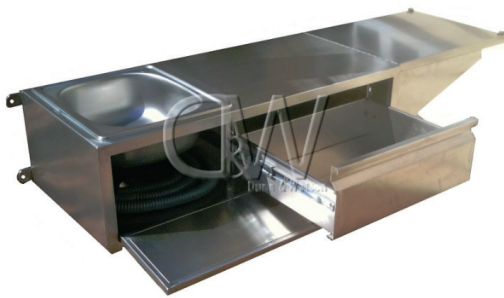

Part No. MH0020

Left Hand Swing:

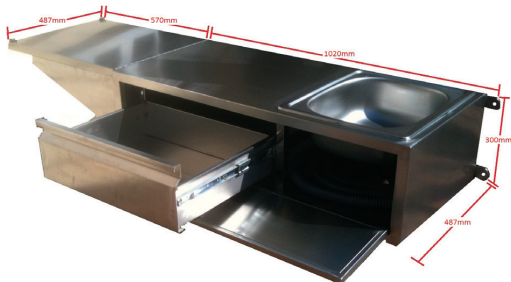
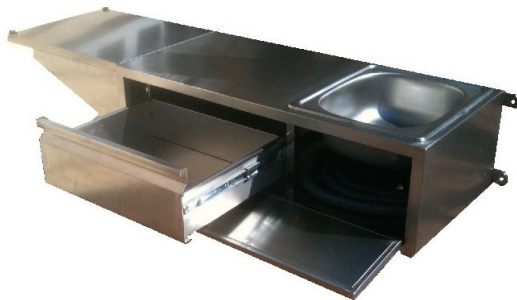

Dunn & Watson



ITEM	STAINLESS SEEL KITCHEN (SUITABLE FOR TAILGATES)
Kitchen Dimension	1020w x 480d x 300h (excluding flip out bench)
Flip Out Bench Dimension	570mm x 455mm
Drawer	1 Large Stainless steel drawer with ball bearing rail
Sink	440mm x 330mm x 140mm
Drainer	Alloy drainer with waste water discharge hose
Latch	Lockable paddle latch
Product Weight	35kg Approx
Mounting	Tailgate Mount, supply with screws, washer, seal
Mounting Clearance	Min Clearance 1200mm x 440mm (base on hand pump setup)
Packing	Well packed in one carton box with foam block and sheet, paper angle protected inside
Packing Dimension (volume)	1060mm x 520mm x 370mm approx
Packing Weight	41kg

SINKS:

Great for making your own kitchen unit for your camper trailer, caravan, horse float, etc.

Kit Includes:

Sink, Alloy Drain, Waste disposal hose

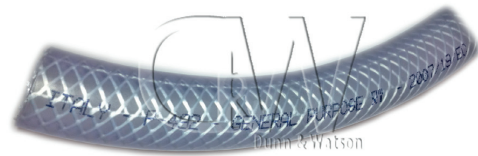

13 - MISCELLANEOUS HARDWARE

Phone: 07 3077 6699 Fax: 07 3103 8650
Email: sales@dunnandwatson.com.au

135

Part No. MH0017

Small

(360mm W x 310mm L x 140mm H):



Part No. MH0016

Medium

(440mm W x 330mm L x 140mm H):



Part No. MH0019

Hand Pumps:



Part No. MH0020

Slide & Swing Fridge Slide:

This allows you to pivot your fridge unit either to the left or the right increasing work space in and around the tailgate area. No Longer is your fridge slide and tailgate kitchen an impractical combination.

This unit features:

- Left or right hand swing
- Strong and reliable Australian design and manufacture
- Universal fit
- Comes with Nylon blocks to pack out walls if your trailer wall isn't flush
- Powder coated aluminium body
- Pull Out Table beneath unit
- Track fitted to the wall allows Fridges to sit as low as 10mm off the floor

AU PATENT APPLN 2012902143

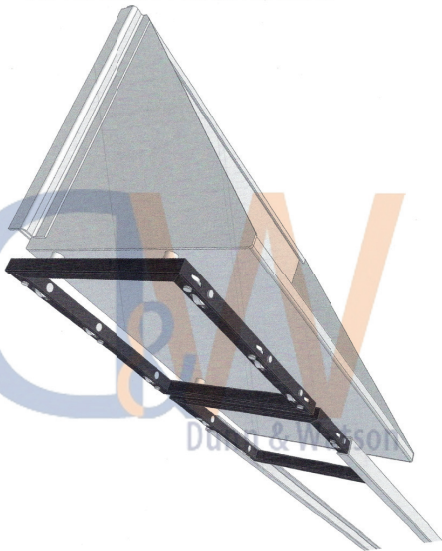

Dimensions:

AU PATENT APPLN 2012902143



AU PATENT APPLN 2012902143



AU PATENT APPLN 2012902143



TRUCK AND TRAILER ACCESSORIES:

Cargo Track:

Fitted to the interior wall of trucks and refrigeration bodies. Supplied in 3000mm lengths and available in zinc or stainless steel.

Part No. MH0012

Zinc Cargo Track

Part No. MH0011

Stainless Cargo Track

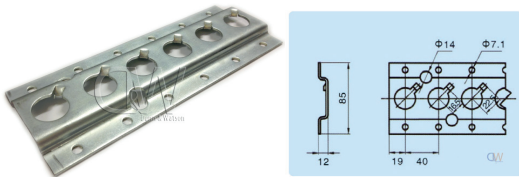

Cargo Track End Cap:

Fitted to the ends of cargo track. Available in zinc or stainless steel.

Part No. MH0013

Stainless Cap

Part No. MH0014

Zinc Cap

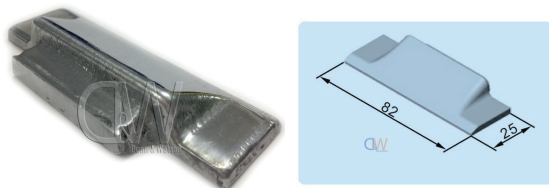

Part No. MH0015

Shoring Bar:

Designed to Lock in between cargo track. Typically used when trucks are carrying lighter or not full capacity loads. Assists in cargo rolling around cabin trailer.

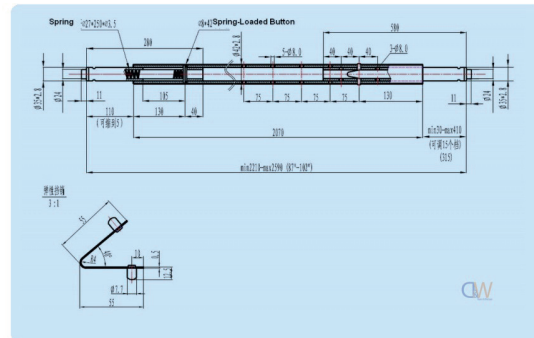

JOCKEY WHEELS – SOLID RUBBER WHEEL:

MH0031 – 6”

MH0032 – 8”

MH0033 – 10”

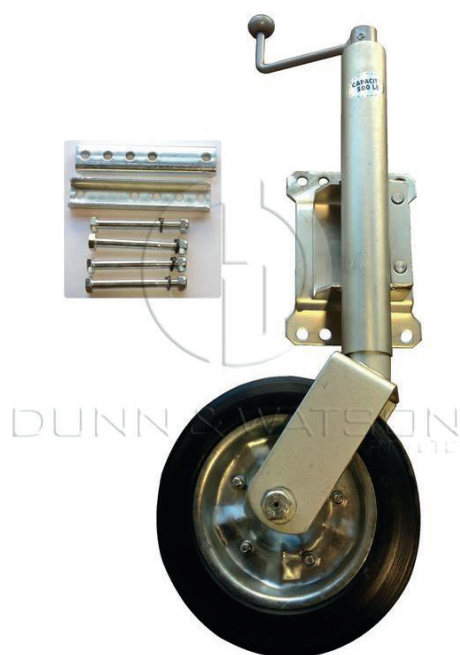

13 - MISCELLANEOUS HARDWARE